

75

16/01/2018
VC142

NESTING DIAGRAMS

The information in the table to Clause 74 is set out in the following diagrams as a means of indicating the nesting of land use terms.

Land use terms that are not nested are listed separately. If there is any inconsistency between the table and the diagrams or list, the table to Clause 74 prevails.

75.01

Accommodation group

15/12/2008
VC50

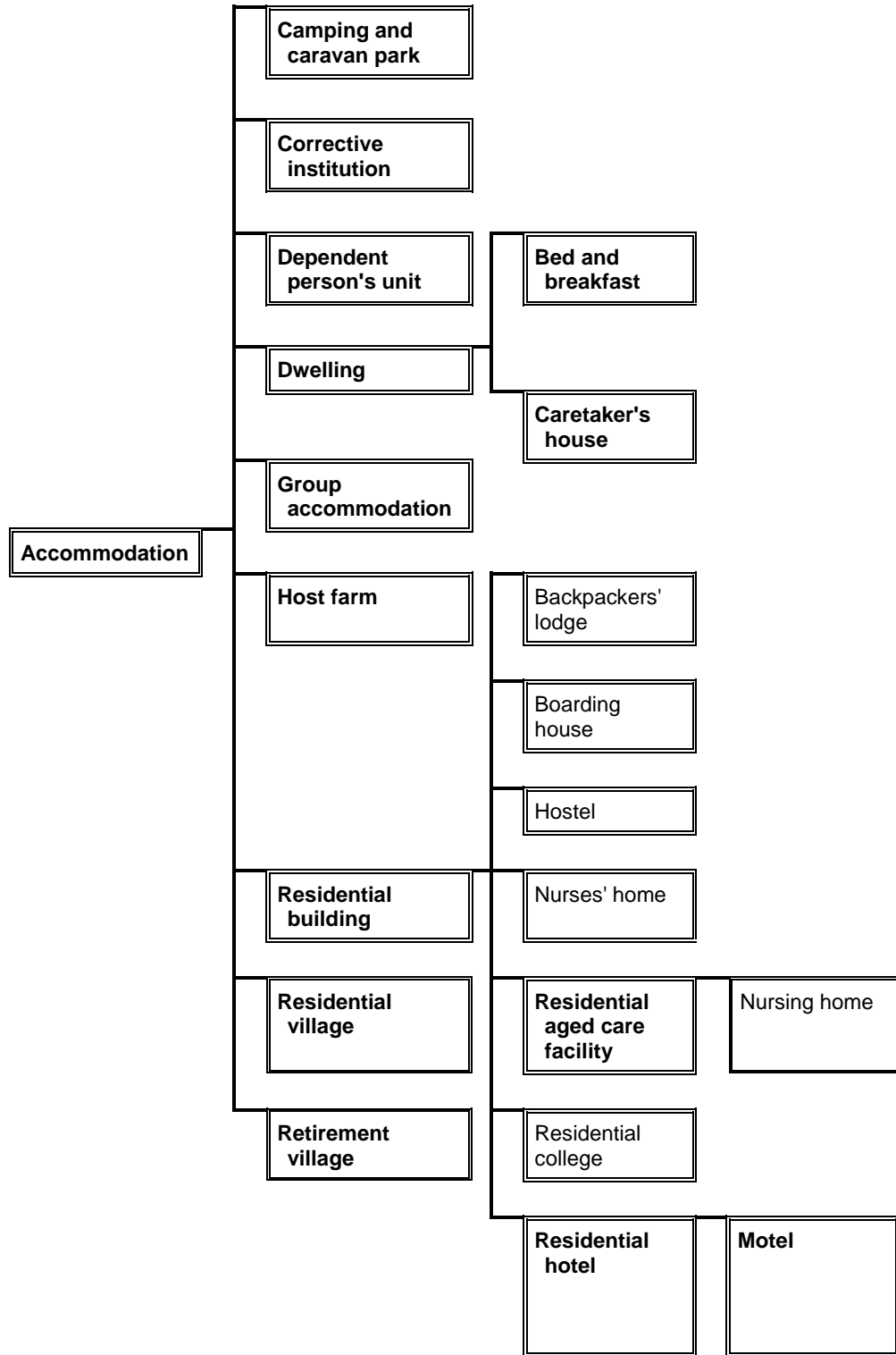

Agriculture group

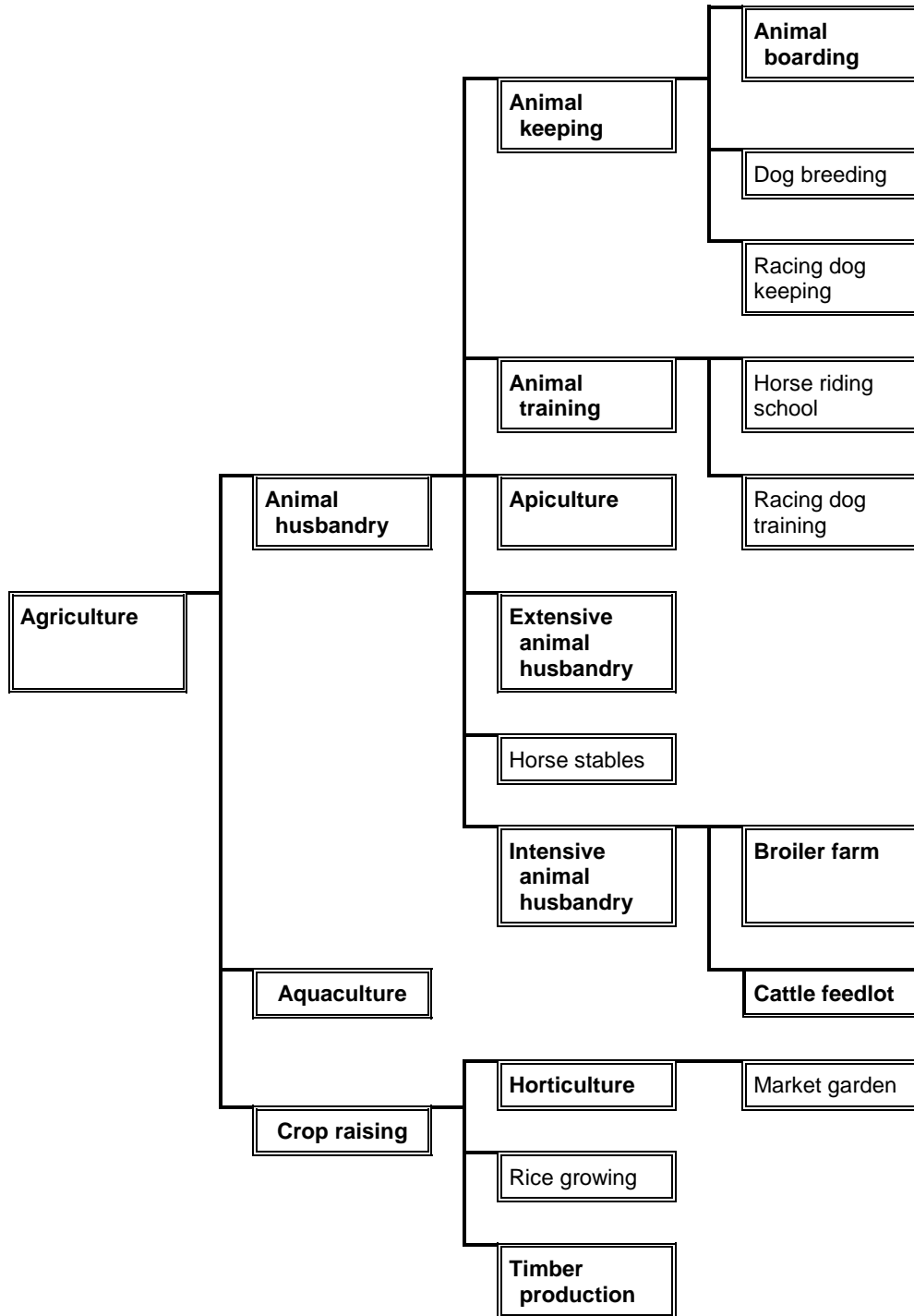

75.03

Child care centre group

09/10/2006
VC42

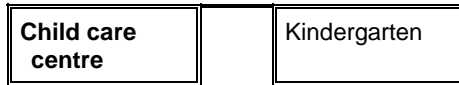

75.04

Education centre group

16/01/2018
VC142

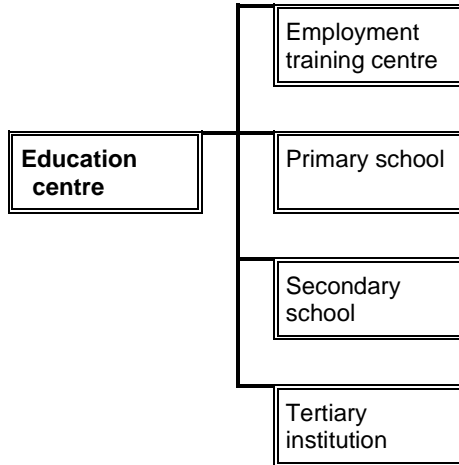

75.05 Industry group

08/08/2012
VC87

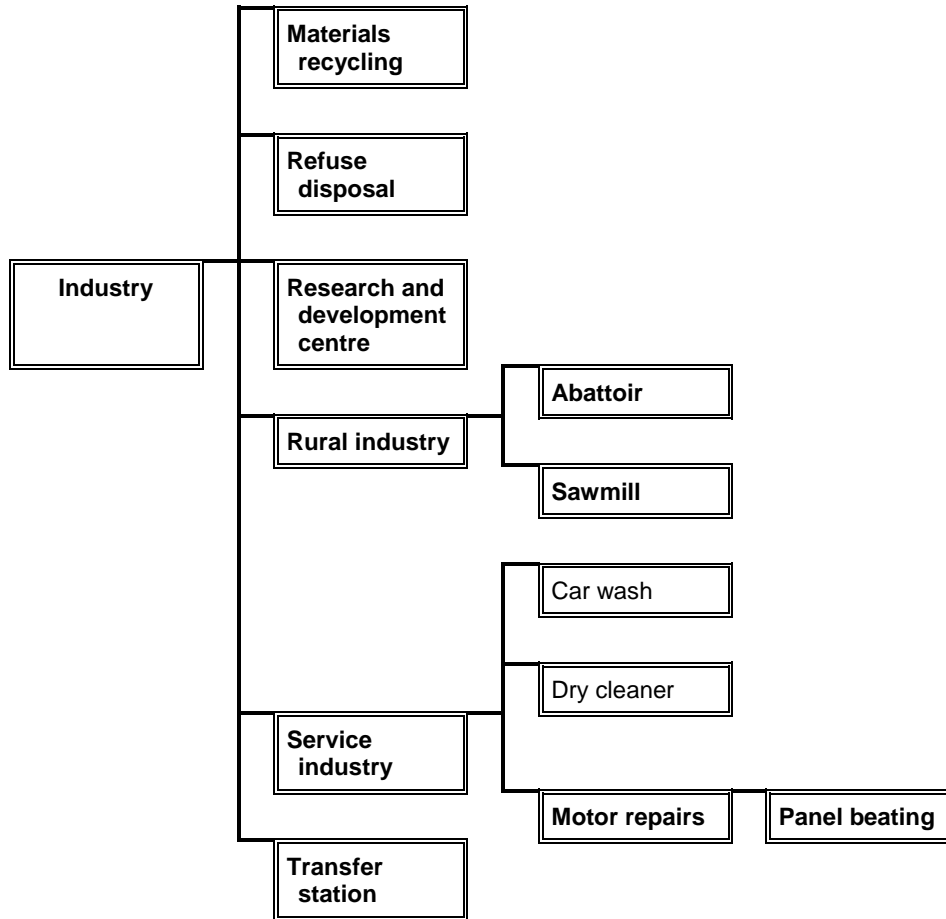

75.06

Leisure and recreation group

16/01/2018
VC142

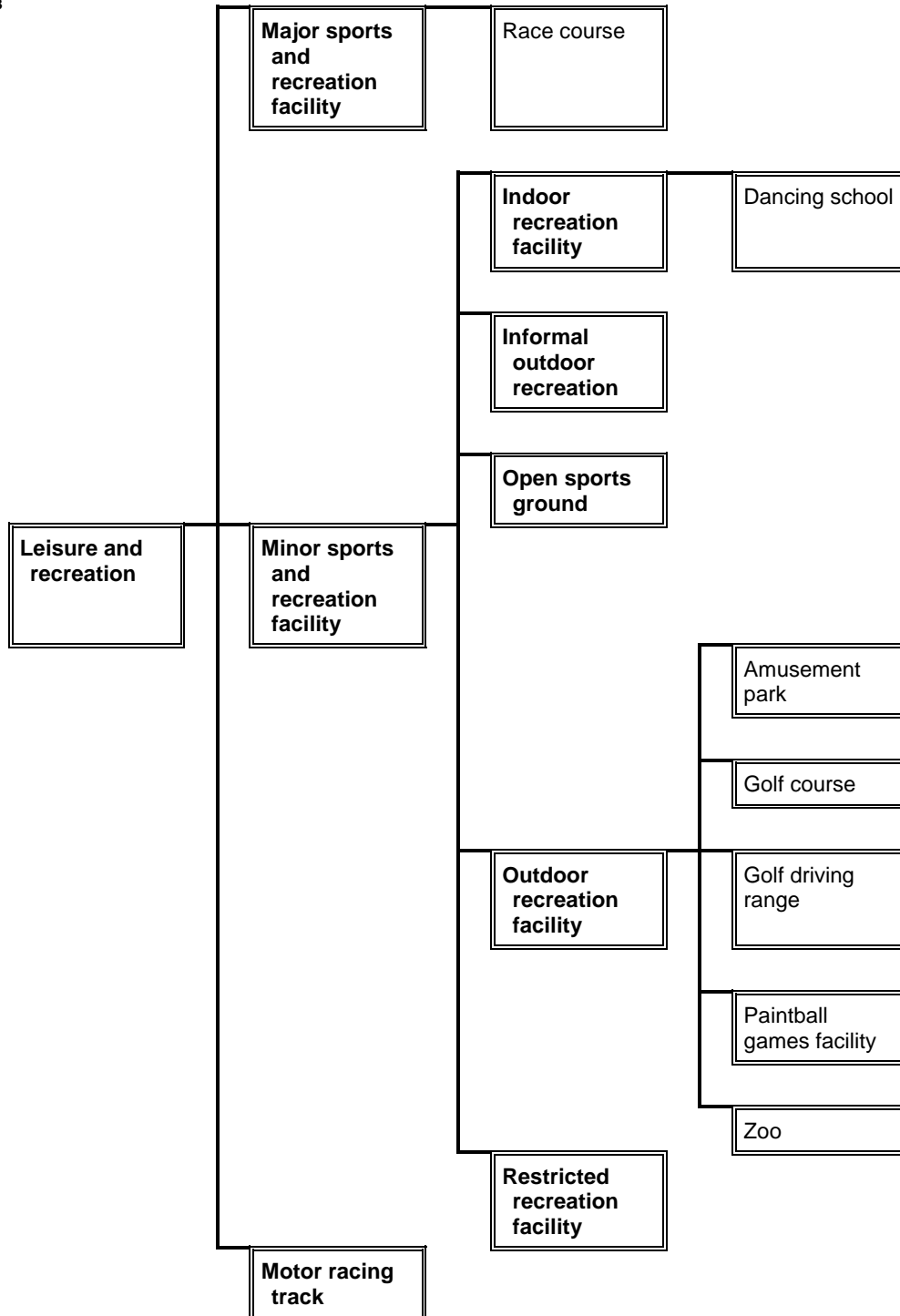

75.07

Earth and Energy Resources Group

23/09/2011
VC77

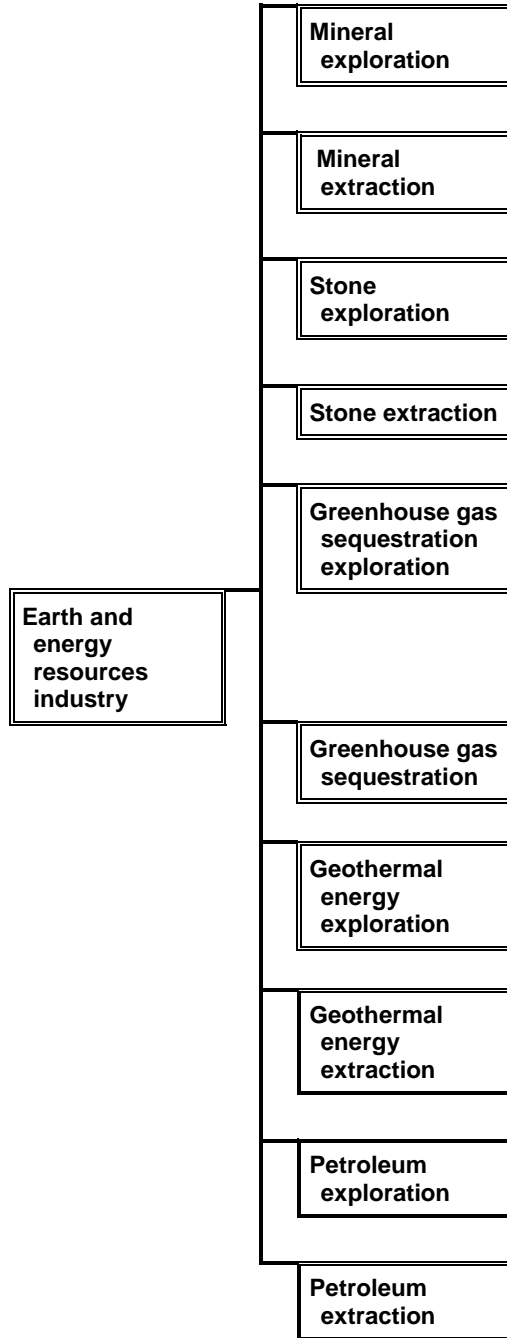

75.08
09/10/2006
VC42

Office group

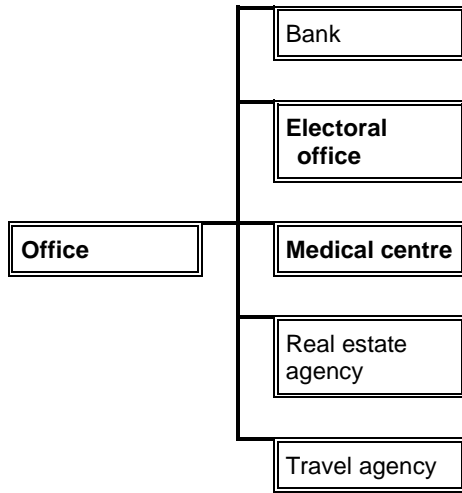

75.09

Place of assembly group

16/01/2018
VC142

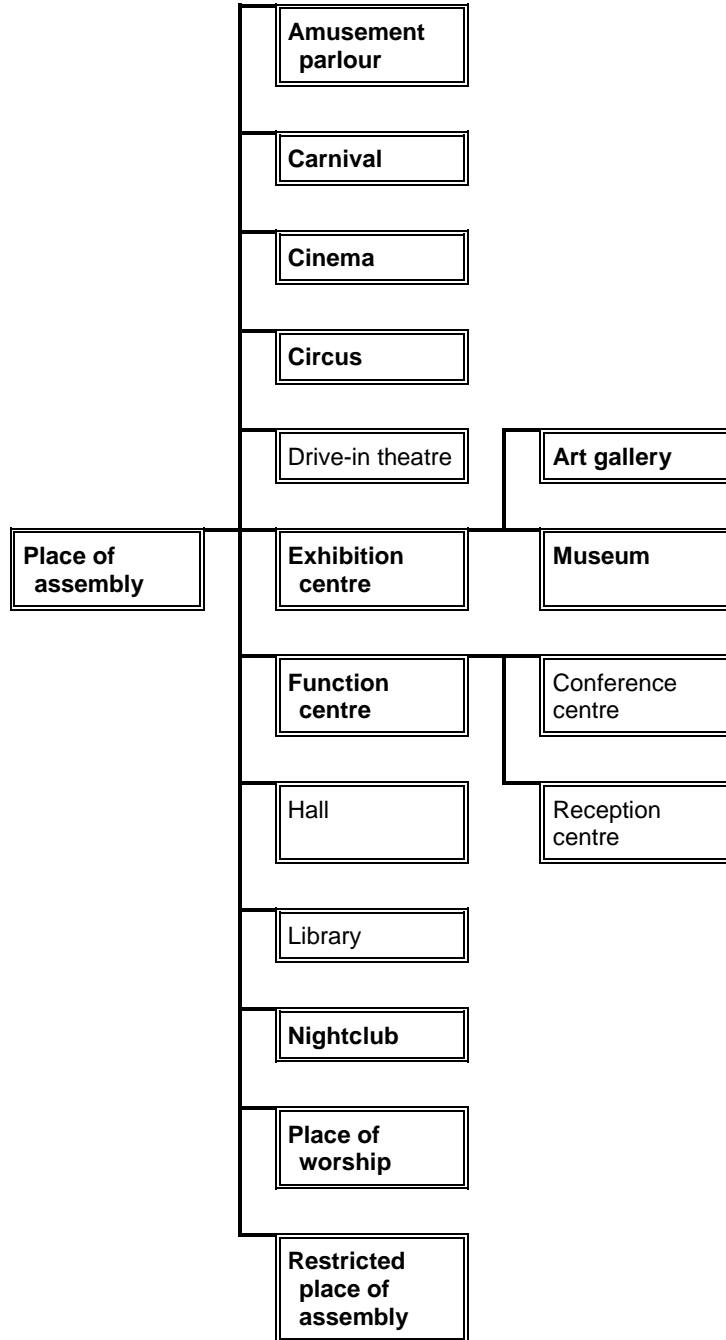

75.10
16/01/2018
VC142

Recreational boat facility group

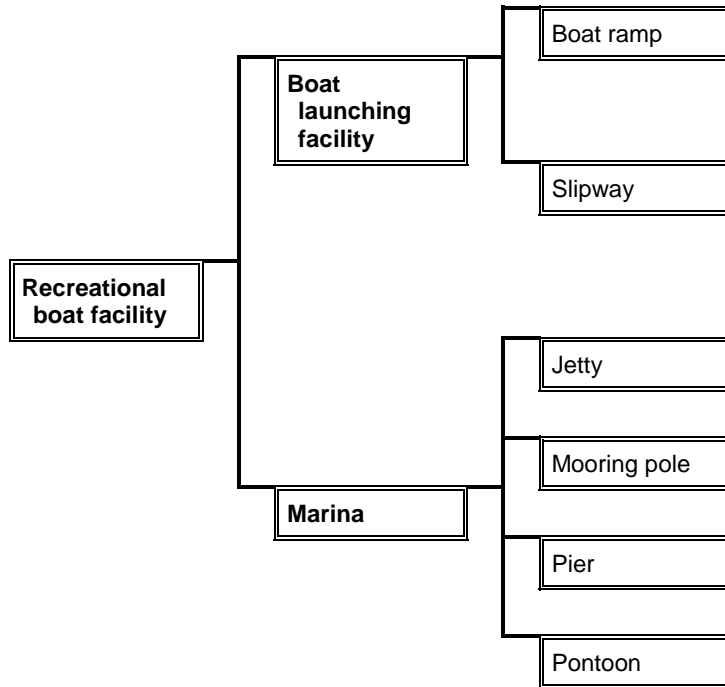

Retail premises group

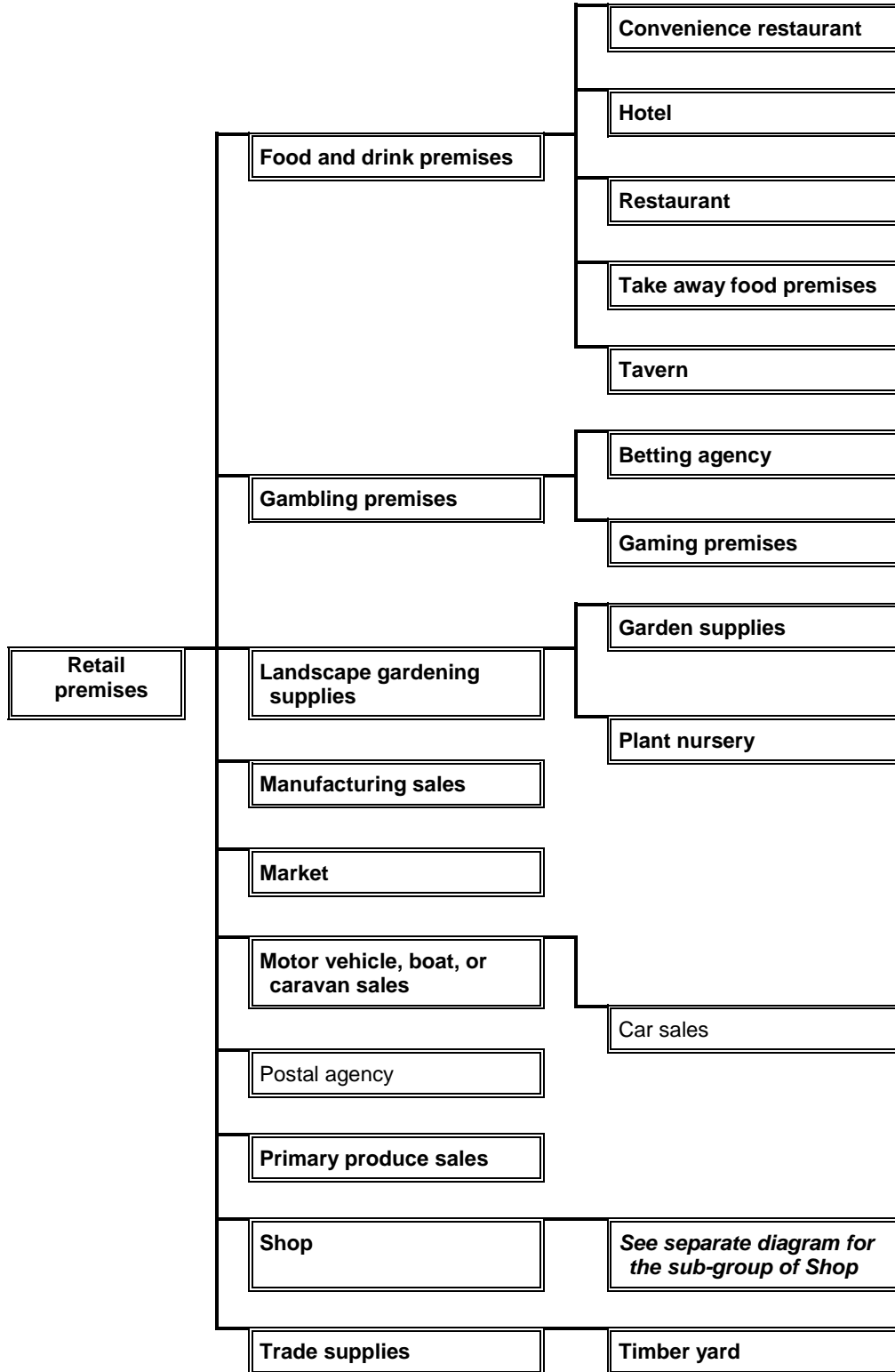

75.12
16/01/2018
VC142

Retail premises group (sub-group of Shop)

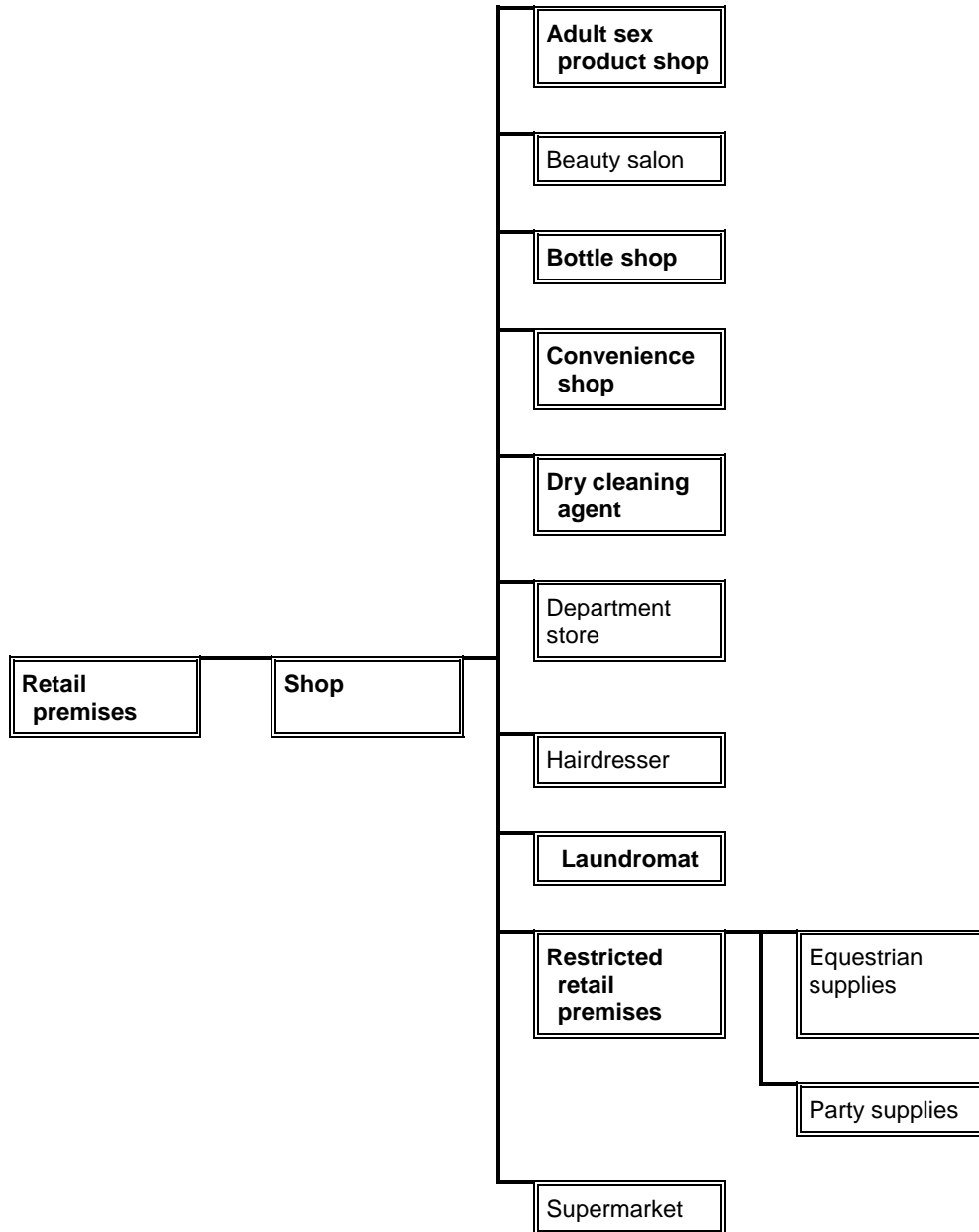

75.13

Transport terminal group

09/10/2006
VC42

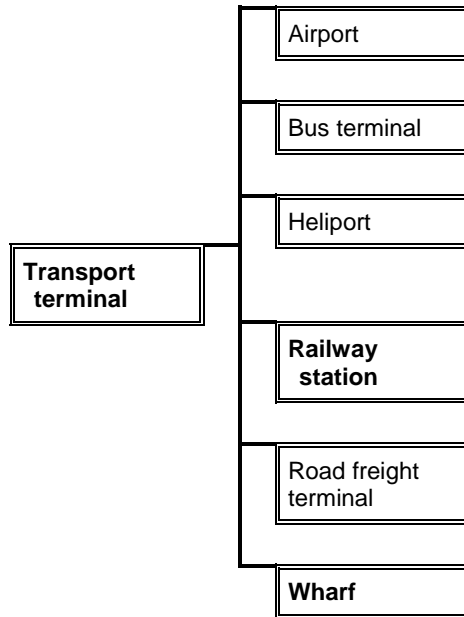

75.14

Utility installation group

09/10/2006
VC42

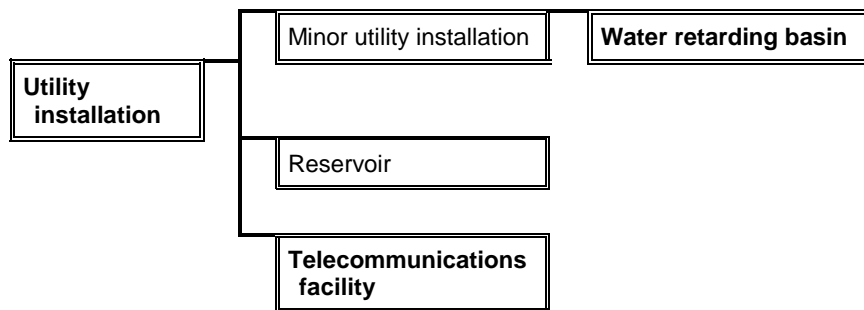

75.15

Warehouse group

09/10/2006
VC42

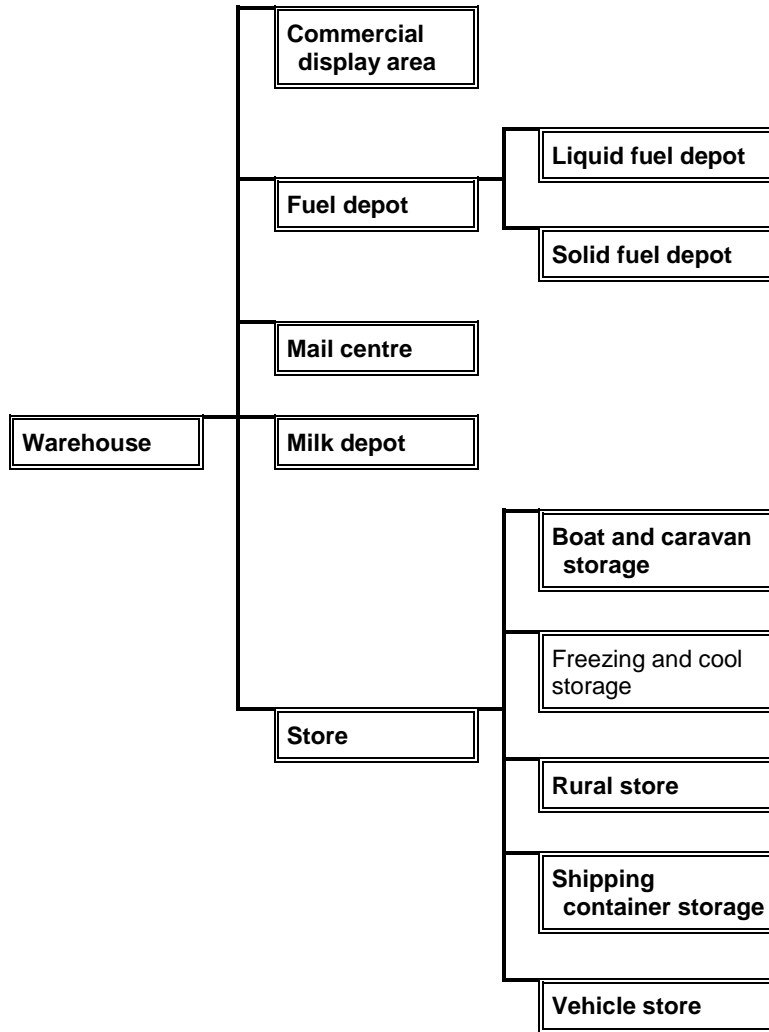

75.16

Renewable Energy Group

21/09/2009
VC60

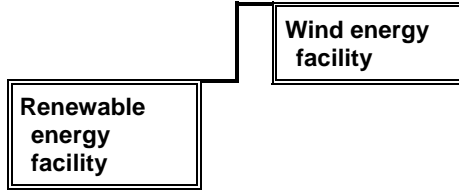

75.17

16/01/2018
VC142

Land use terms that are not nested

Art and craft centre
Brothel
Car park
Cemetery
Cinema based entertainment facility
Crematorium
Display home
Emergency services facility
Freeway service centre
Funeral parlour
Helicopter landing site
Home based business
Hospital
Natural systems
Research centre
Saleyard
Service station
Tramway
Veterinary centre
Winery